

Article number: 60415447019

Description: Timing Belt Pulley 47 AT10 19/2

## Measures

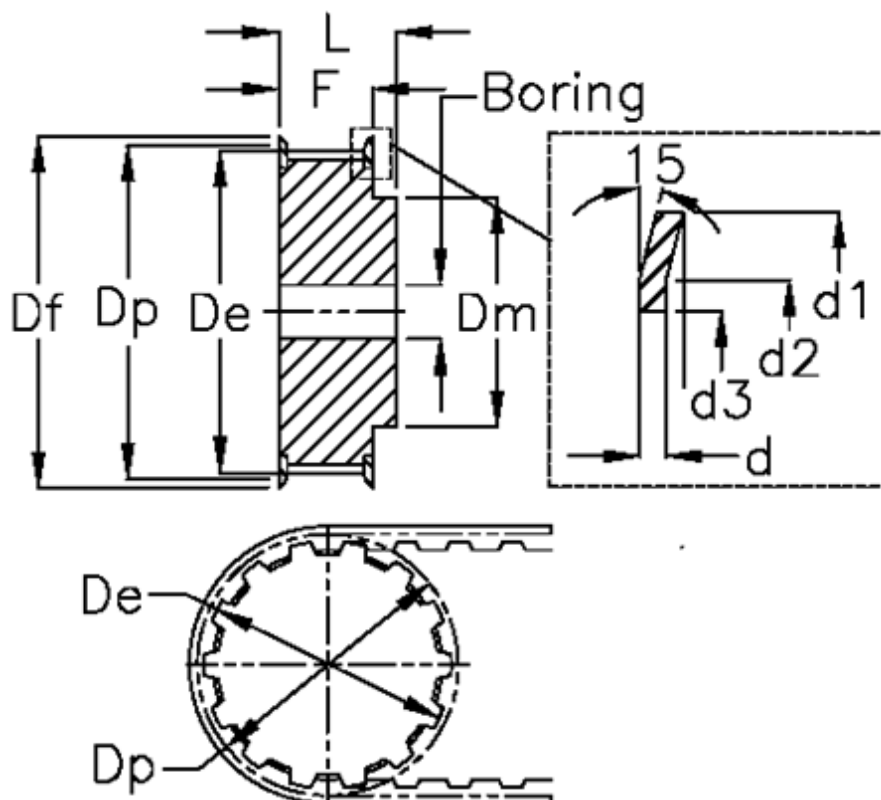

Belt width = - 32 mm	$D_p$	= 60.65
$d$ = 1	$F$	= 37
$d_1$ = 66	Flange type	= F25
$d_2$ = 63	$L$	= 47
$d_3$ = 52	Pre-drilled	= 10
$D_e$ = 58.65	Tooth number	= 19
$D_f$ = 66	Type	= AT10
$D_m$ = 44	Weight	= 0.286